



NVS-IPVD1B  
.....

**CAMERA**



# USER MANUAL

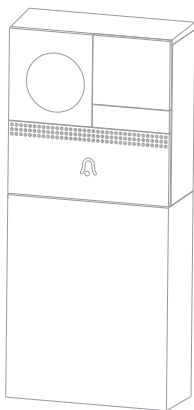

 Smart

## Functions

### Remote wake-up

The doorbell will be in a sleep mode to save power; you can have a preview in App and have a remote wake-up to monitor after 3-4 Seconds.

### Full-duplex audio

When the visitor push the doorbell button, you will get a call. You can see and hear the visitor in your App from the doorbell if you answer.

### PIR

When the doorbell detects someone stopping by, it sends an alarm message to your cell phone.

### Low battery alarm

You can set a low-battery alarm threshold on your phone App. The threshold is set to a minimum of 10% and a maximum of 50%. When the battery power of the doorbell is lower than the set threshold, the App will have a reminder.

### Battery Lock

After battery box connected, it will be locked immediately. User have to unlock the battery box in the App setting page to if want to take out the battery box, only 30 seconds allowed.

### Shared device

The doorbell device can be shared with friends, and friends can also preview online. There is no limit to the number of sharing devices, but only 6 accounts are supported for online preview at the same time.

## What's in the box

Consult the checklist below for all components.



Doorbell



Power converter



Back cover



Battery box



Power adapter



USB cable



Pin



A x 4

B x 4

C x 2

D x 1

Screws(4 kinds)



I/M



Wire nuts



Adhesive table

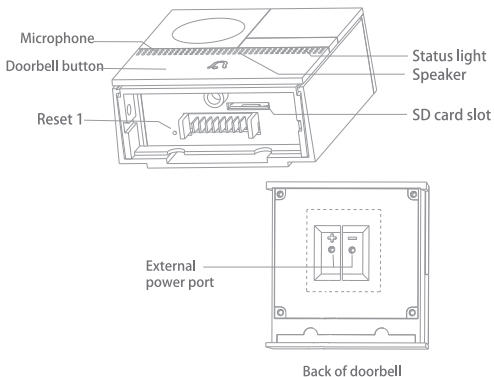

## Description

Power Port	DC 5V $\pm$ 10%, use the screws to fix the power converter
Doorbell button	Press the button to activate the doorbell
Status light	<ul style="list-style-type: none"> <li>Red light solid on: the camera network is abnormal</li> <li>Red light blinking: awaiting WiFi connection, or currently connecting (faster blinking)</li> <li>Blue light solid on: camera running correctly</li> </ul>
Microphone	Captures sound for your video
SD card slot	Supports local SD Card storage (Max.128G)
Reset1	Press and hold on for 5 seconds with pin to reset the doorbell (unable to unbind the bell from account)

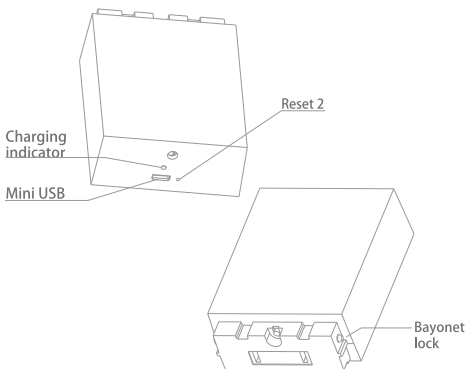

#### Description

Mini USB	DC5V±10%,USB power supply
Charging indicator	<ul style="list-style-type: none"> <li>•Red indicator solid on: battery is charging</li> <li>•Blue indicator solid on: finishing charging</li> </ul>
Reset 2	Tap reset button for 5 seconds to factory reset (it will not unbind the device)
Bayonet lock	Lock the battery box through bayonet lock
Battery capacity	6000mAh (Two 18650 lithium-ion batteries)

## Connect

### Download

Smart Life is available for both iOS and Android OS. Search the name 'Smart Life' in App Store or Android Market, or scan upper QR-Code to download the App.

• Support



iOS



Android



Scan for app QR code

### Set up router

This device only supports 2.4GHz frequency band router, does not support 5GHz frequency band router, please set the relevant parameters of the router before WiFi configuration, WiFi passwords do not include special characters such as ~!@#\$%^&\*(). When the device is configured in WiFi, the mobile phone and device are as close as to the router, which can speed up the configuration of the device.

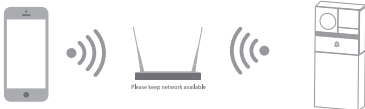

## Registration process

Step 1 Open the TuyaSmart app, click "Register", read the "Privacy Policy" and click "Agree".

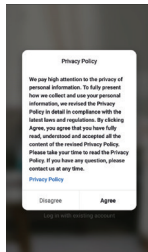
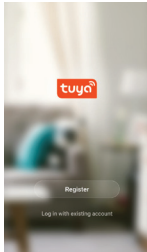

Step 2 input a legal and valid Mobile number or Email address and click "Continue". Input Verification Code, then log in the app.

### Register

Canada +1 >

Mobile number/Email

Continue

I agree with Service Agreement and Privacy Policy

### Verification Code

Verification code has been sent to: admin@gmail.com, Resend (56s)

## QR Code Configuration

### Getting started

1. Please follow the instructions and make sure the password is inputted correctly.
2. One device can only be added with one App account, if the device has been added with another account already, then it can't be added to any another account again.
3. The device will be unbind from previous account after been deleted from App. Further, the device will be resetted automatically once from blue light to red light.

### Process

Step 1 Open the TuyaSmart app, click "+" or "Add Device". Then select "All" on the "Select Device Type" page.

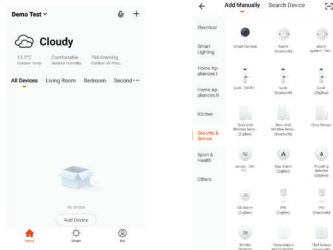

Step 2 Select "Security Camera". Power the device on and make sure the indicator is flashing quickly or a prompt tone is heard.



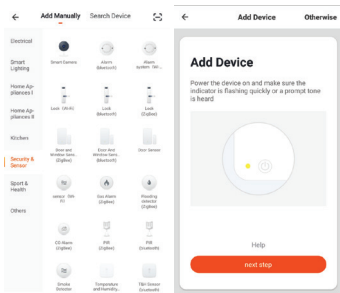

Step 3 Input WiFi password and click "Confirm", scan the QR Code with a device. (You can change the network connection)

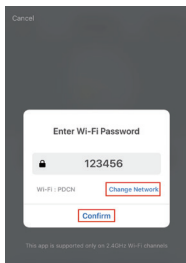

About 20cm

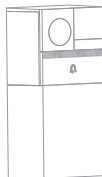

Step 4 Click "I heard the beep" when the device comes out "dong dong dong". And you can complete the configuration about 30s.

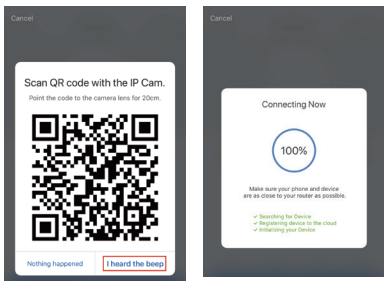

Step 5 The device is added, and the device nickname can also be changed in this interface.

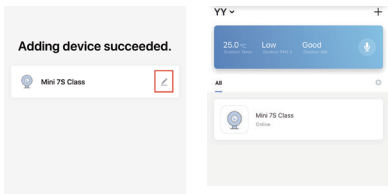

**Notice:** After the device configured successfully, it will be automatically locked. Motor in the battery box will make a sound. Click "Click to Unlock the Battery" first before unplugging the battery.

## FAQ

Q: In the network process, the process bar is always not 100%, add failure?

A: This camera only supports 2.4GHz WiFi router, please make sure you are using a 2.4GHz WiFi router. And confirm the WiFi password again.

Q: Repeated additions are failures?

A: After adding a failure, it is recommended to restart the device or power off, and then try to add again.

Q: The device cannot be previewed properly?

A: Check whether the network is normal, you can place the camera close to the router, and if not, it is recommended to reset the device and add it again.

Q: How to cut the camera network to another router?

A: First remove and reset the device on the App and then configure the device again by the App.

Q: Why I can't get the notifications with my cell phone App?

A: Please confirm that the App has been running on the phone, and the relevant reminder function has been opened; Message notification and authority confirmation in the mobile phone system have been opened.

Q: Why doesn't the device identify the SD card?

A: It is recommended to plug in SD card after power cut. Confirm whether the SD card is normally available and the format is FAT32. And the TF card can't be identified when the internet environment is not good.

## Unlock

Step 1 Click "...", enter the "Setting" page and click "Basic Feature Settings".

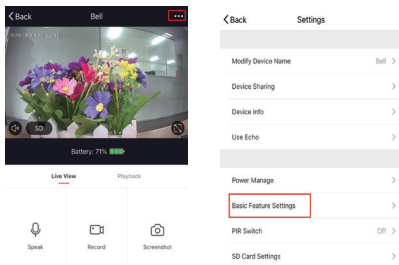

Step 2 Enter the "Basic Feature Settings" setting page and click "Unlock the Battery" to unlock it automatically. When the motor is finished, the battery box can be pulled out.

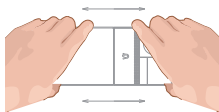
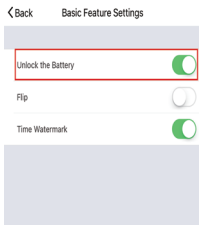

## Install

### Installation of Power supply mode

Warning: Don't fall down during using

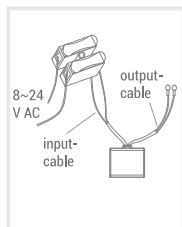

Step 1 Each input-cable (AC 8~24V) connect to the wires which come out of the wall.

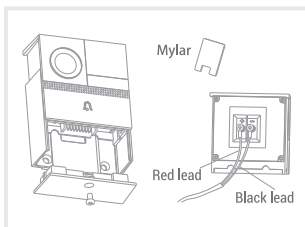

Step 2 Remove the bottom cover and bracket of the doorbell host and lead the output terminal. Connect to the power interface on the back of the doorbell host. Note: red lead connects the power "+", black connects the power "-".

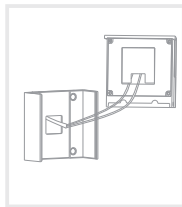

Step 3 Remove the double-sided adhesive on the back of the mylar sheet. Cover the position of the power interface on the back of the doorbell host.

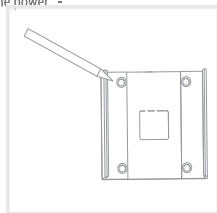

Step 4 Use the marker to draw the positions of the 4 screw holes on the wall surface to be installed.

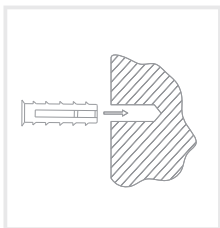

**Step 5** Screw 4 expansion screws into the newly marked position.

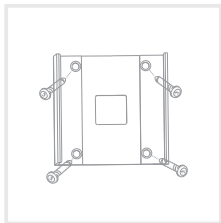

**Step 6** Fix the mounting bracket to the wall.

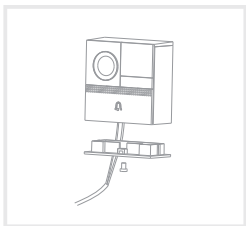

**Step 7** Install the bottom door of the doorbell main unit and fix it with screws.

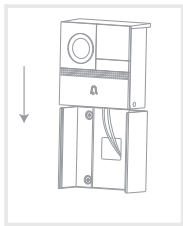

**Step 8** Pull the power cable from the center hole of the bracket and slowly insert the doorbell into the door as shown in the above figure (be careful not to catch your finger).

**Install the device in battery-powered mode**

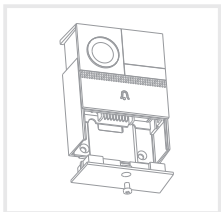

**Step 1** Remove the doorbell bottom cover and bracket as shown in the figure

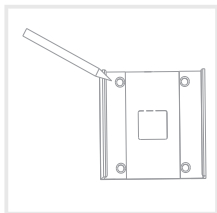

**Step 2** Use the marker to draw 4 screw holes on the surface of the wall to be installed

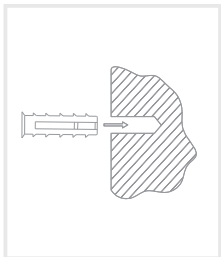

**Step 3** Screw 4 expansion screws into the newly marked position

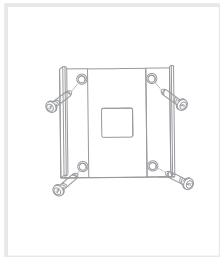

**Step 4** Fix the mounting bracket to the wall

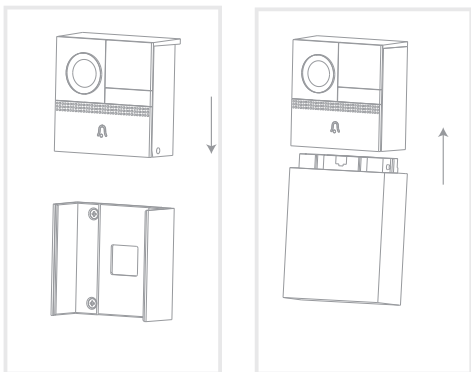

Step 5 Snap the doorbell into the bracket

Step 6 Align the battery box with the bayonet lock, and push the battery box into doorbell.